



- 1. Iguana Circo Freestanding
- 2. Iguana Circo Pillar cover
- 3. Iguana Circo Wall mounted model
- 4. Iguana Circo Corner
- 5. Iguana Aplano
- 6. Iguana Arco
- 7. Iguana Visio



1

2

- 1. Iguana Circo Freestanding Top view
- 2. Iguana Circo Freestanding

4

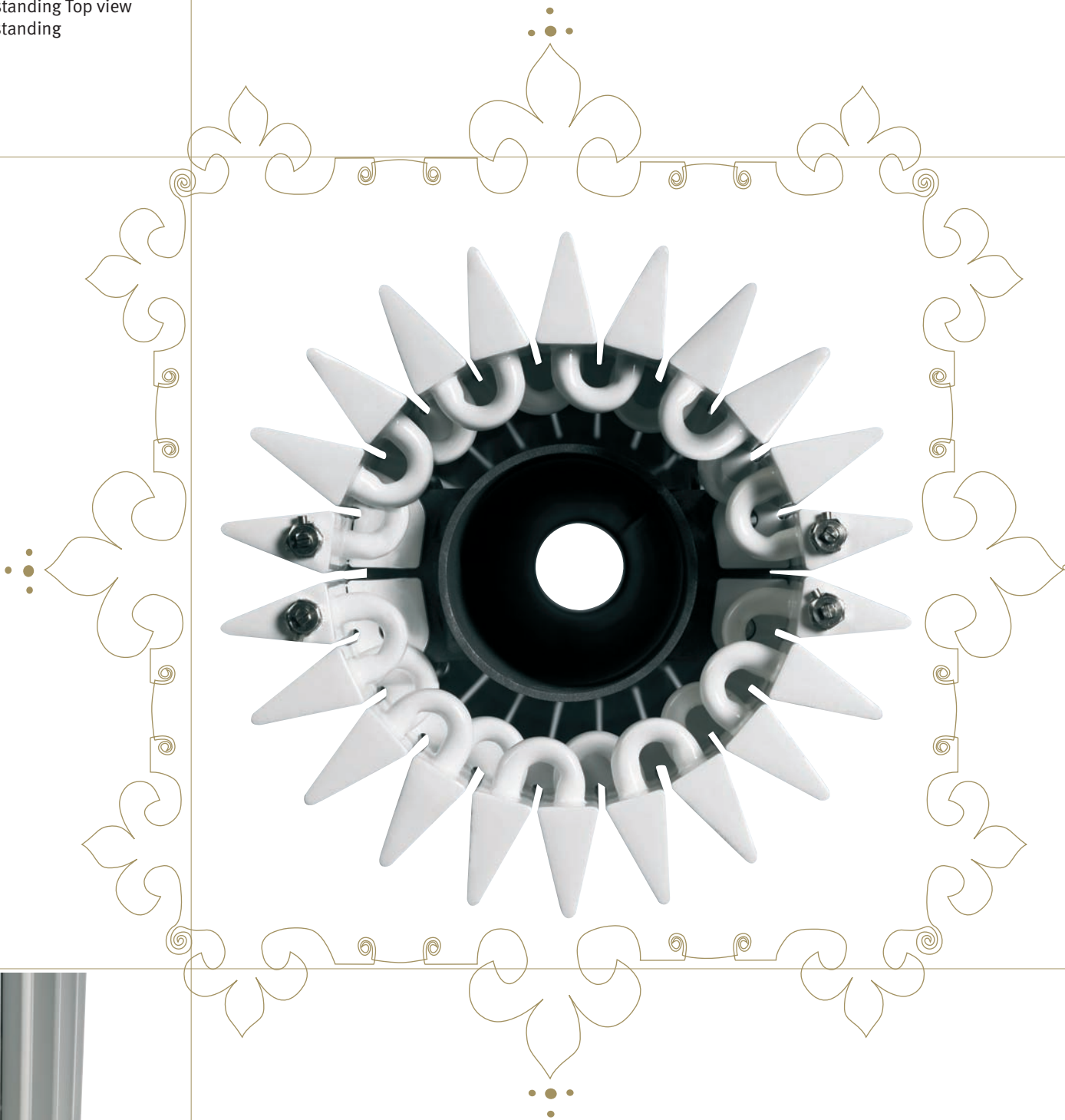

*Iguana Circo Freestanding*



# Iguana Circo Freestanding Dimensions

## CIRF\_Circo Freestanding

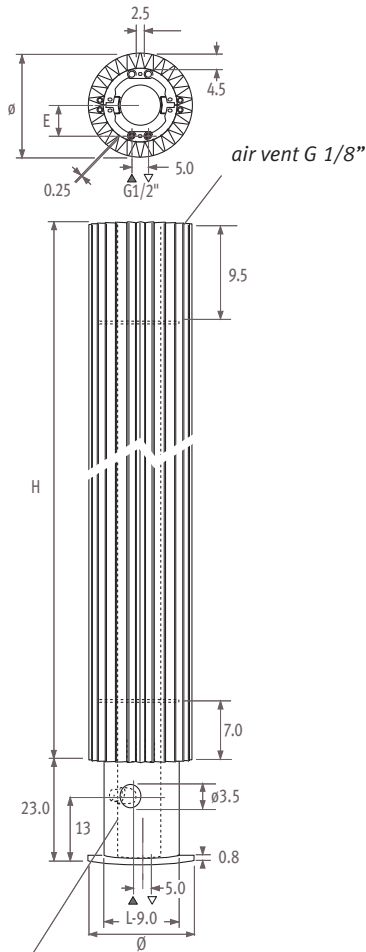

Metal suspension column included

### Position flow and return pipe

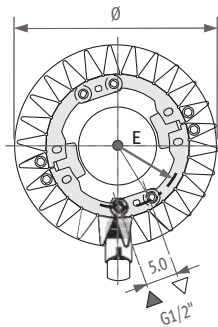
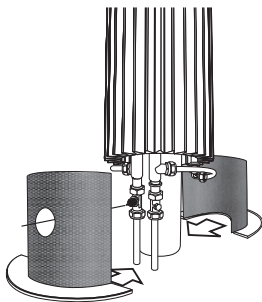

Standard delivery:  
guard and connection set with thermostatic valve and lockshield included.  
Sleeve couplings for Connection sets with guard see page 209.

Dimensions in cm

Ø	27.8	31.3	34.8
E	7.5	9.4	11.3

## Connections

### Two pipe

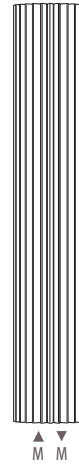

### Standard connection Code MM

Please note:  
With the guard the standard flow is on the left. If a right hand flow is required please amend the code suffix using MM/CR

#### Notice

To guarantee the output of the Iguana models and to limit the pressure drop, Jaga recommends the use of tube diameter 16/2, 18/1 or 18/2.

## Dimensions options

### Table

Ø	27.8	31.3	34.8
L	66.0	73.0	80.0
D	50.0	55.0	60.0

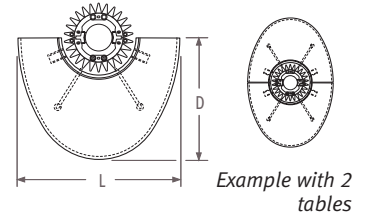

### Large shelf

Ø	27.8	31.3	34.8
L	63.7	67.2	70.7
D	31.2	32.9	34.7

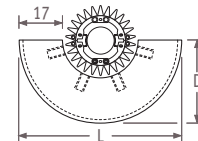

### Small shelf

Ø	27.8	31.3	34.8
L	49.7	53.2	56.7
D	24.2	25.9	27.7

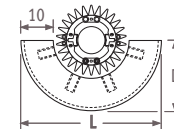

### Towel rail

Ø	27.8	31.3	34.8
L	42.7	42.7	49.3
D	22.1	22.1	25.3

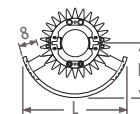

### Hat rack

Ø	27.8	31.3	34.8
L	42.7	42.7	49.3
D	22.1	22.1	25.3

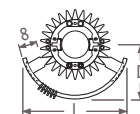

## Outputs

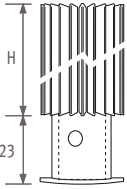
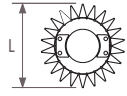

### Standard delivery:

- Iguana Circo in 2 parts, to be mounted around the suspension column, incl. all pieces for hydraulic connection
- support with suspension column and guards with opening for the valve head
- thermostatic valve 5094.430
- lockshield 5094.431
- 4 chrome-plated air vents G 1/8"
- sleeve couplings: see Connection sets & Valves

### Standard colours:

- sandblast grey metallic 001
- white 301(RAL 9010 satin)
- white 333(RAL 9016 satin)

## Iguana CIRF

code height length colour conn.  
ORDERING CODE: CIRF. 180 027. XXX /MM/CL

H		L 027	031	034
180	75/65/20	1602	1893	2184
	90/70/20	2081	2460	2838
192	75/65/20	1707	2018	2328
	90/70/20	2211	2613	3015
200	75/65/20	1773	2096	2418
	90/70/20	2291	2708	3125
220	75/65/20	1923	2272	2622
	90/70/20	2471	2919	3369
240	75/65/20	2048	2421	2793
	90/70/20	2617	3094	3569

## Options

### Table in beech veneer

CODE	Type
9087.012660	Circo ø 27
9087.012730	Circo ø 31
9087.012800	Circo ø 34

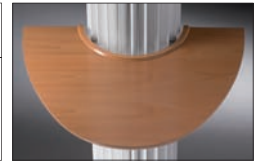

### Large shelf in beech veneer

CODE	Type
9087.010637	Circo ø 27
9087.010672	Circo ø 31
9087.010707	Circo ø 34

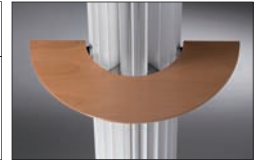

### Small shelf in beech veneer

CODE	Type
9087.011497	Circo ø 27
9087.011532	Circo ø 31
9087.011567	Circo ø 34



### Towel rail chrome-plated aluminium

CODE	Type
9087.013427	Circo ø 27
9087.013427	Circo ø 31
9087.013493	Circo ø 34

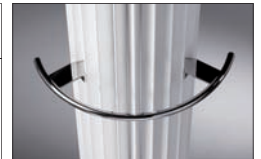

### Hat rack chrome-plated aluminium

CODE	Type
9087.014427	Circo ø 27
9087.014427	Circo ø 31
9087.014493	Circo ø 34



### Deco thermostatic head

CODE	Colour
5090.1111	chrome
5090.1110	chrome / white

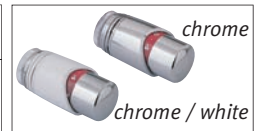

### Foot for concrete floor

CODE	Type
9086.000278	Circo ø 27
9086.000313	Circo ø 31
9086.000348	Circo ø 34

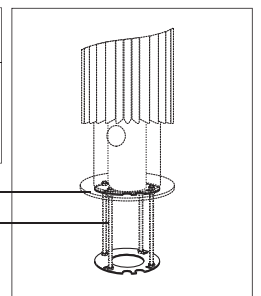

Finished floor level  
Rod (thread M16) not delivered as standard.



Output measured in accordance with EN442, at a water temperature of 75/65 and a room temperature of 20°C (ΔT=50).

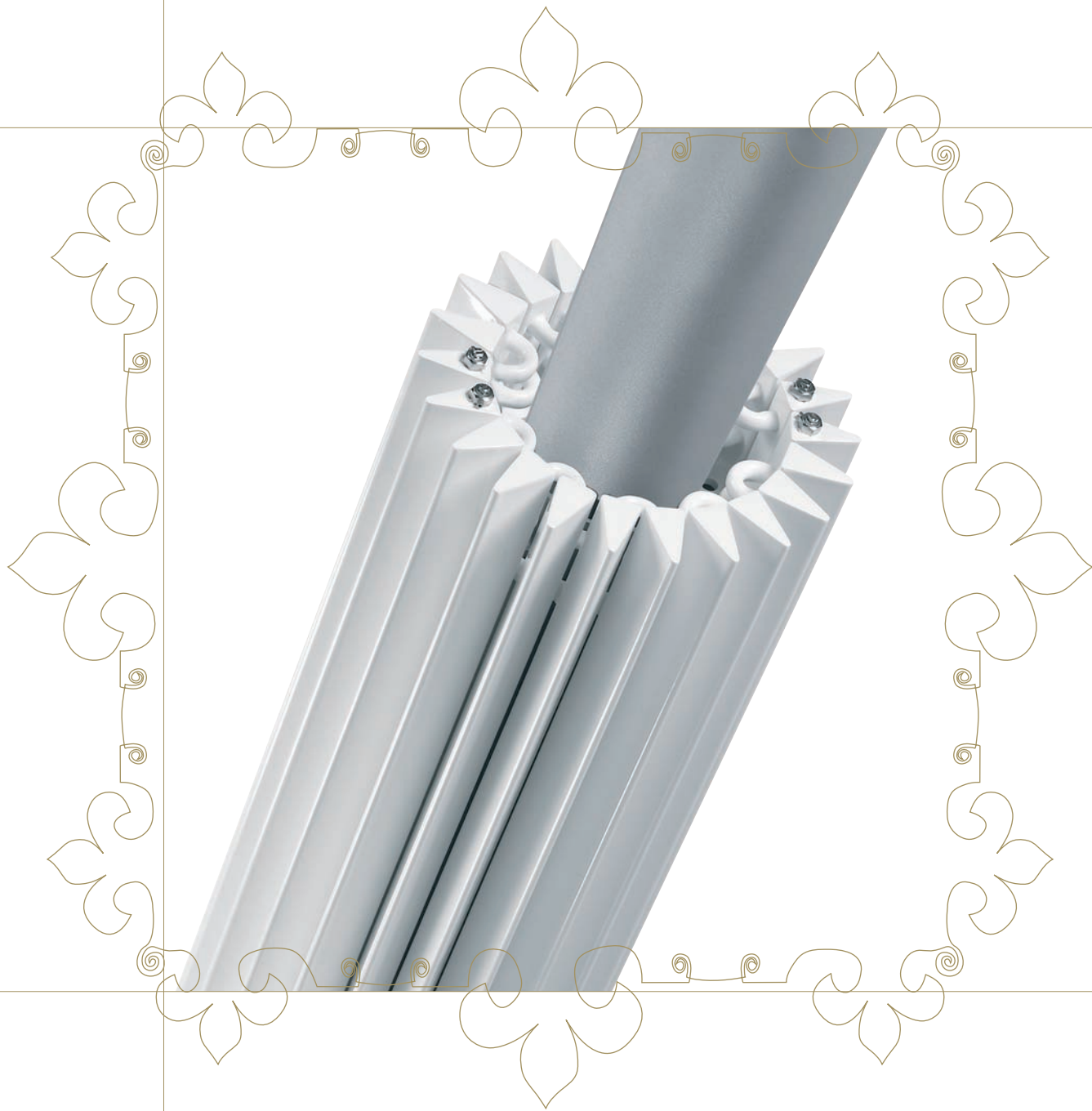

*Iguana Circo Pillar cover*

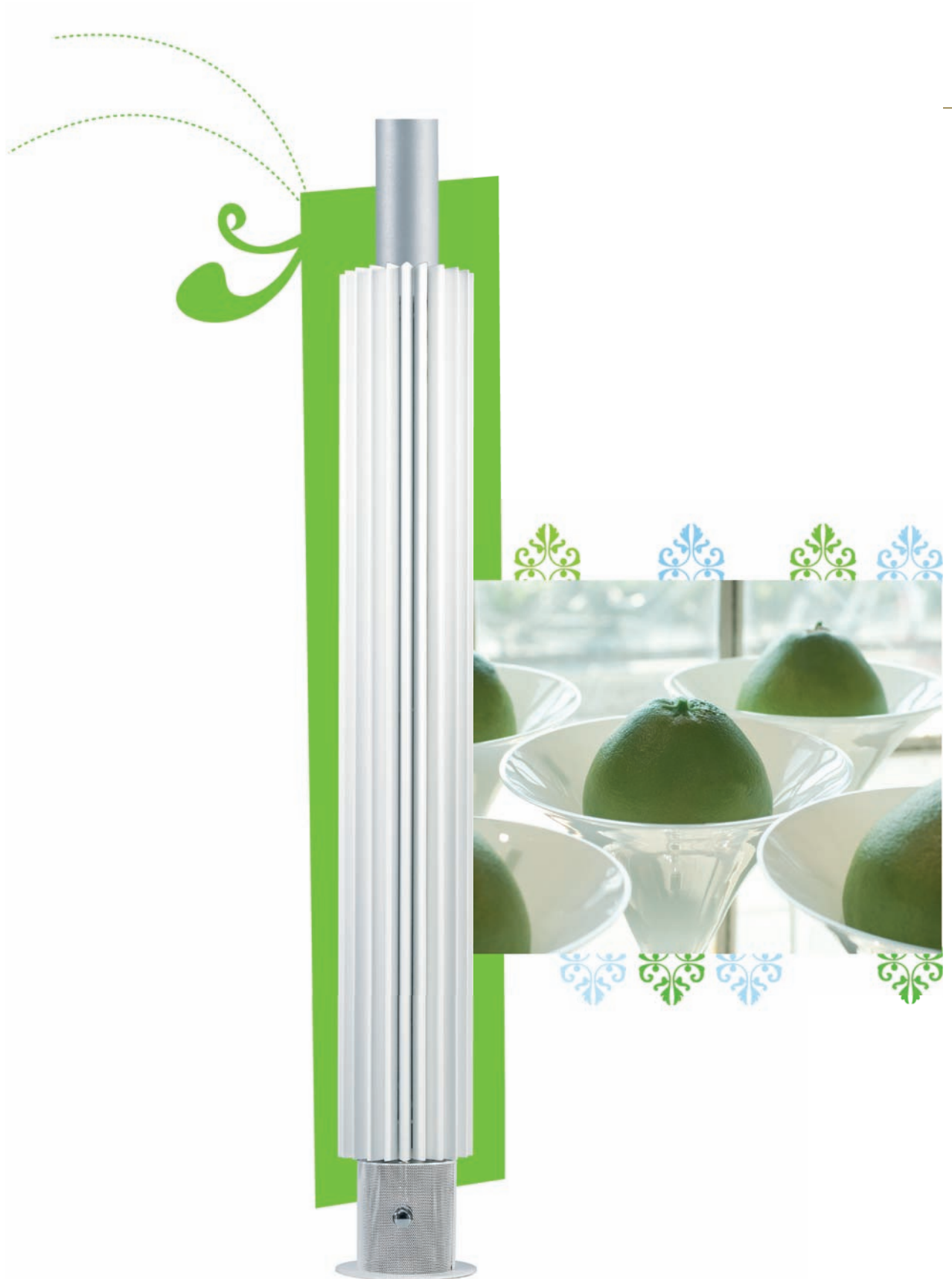

# Iguana Circo Pillar cover

## Dimensions

CIRP\_Circo Pilar

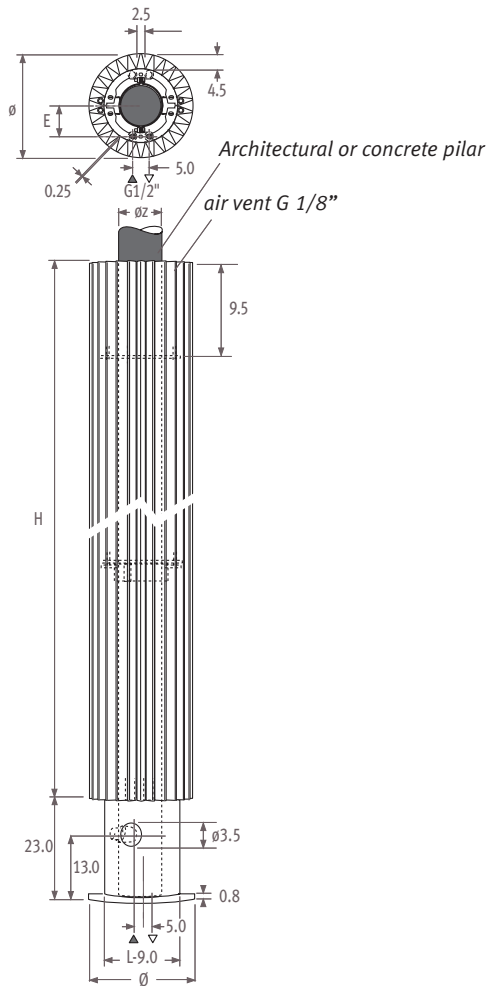

### Position flow and return pipe

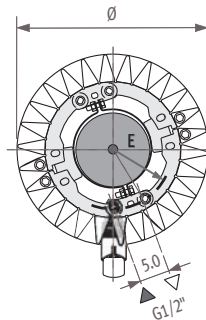
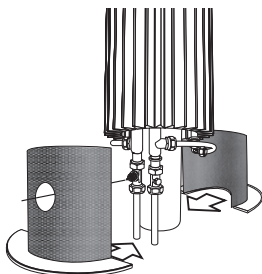

Standard delivery:  
guard and connection set with thermostatic valve and lockshield included.  
Sleeve couplings for connection sets with guard see page 209.

Dimensions in cm

Ø	27.8	31.3	34.8
E	7.5	9.4	11.3
ØZ	11.0	12.5	16.0

## Connections

### Two pipe



### Standard connection

Code MM

Please note:  
With the guard the standard flow is on the left. If a right hand flow is required please amend the code suffix using MM/CR

### Notice

To guarantee the output of the Iguana models and to limit the pressure drop, Jaga recommends the use of tube diameter 16/2, 18/1 or 18/2.

## Dimensions options

### Table

Ø	27.8	31.3	34.8
L	66.0	73.0	80.0
D	50.0	55.0	60.0

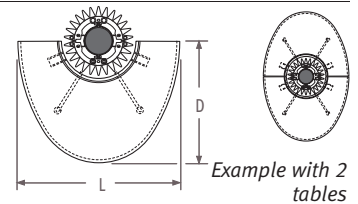

### Large shelf

Ø	27.8	31.3	34.8
L	63.7	67.2	70.7
D	31.2	32.9	34.7

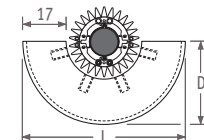

### Small shelf

Ø	27.8	31.3	34.8
L	49.7	53.2	56.7
D	24.2	25.9	27.7

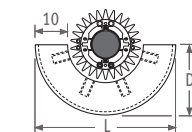

### Towel rail

Ø	27.8	31.3	34.8
L	42.7	42.7	49.3
D	22.1	22.1	25.3

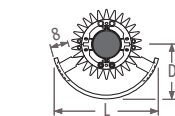

### Hat rack

Ø	27.8	31.3	34.8
L	42.7	42.7	49.3
D	22.1	22.1	25.3

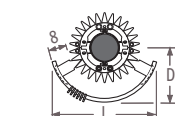



## Outputs

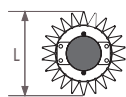

### Standard delivery:

- Iguana circo in 2 parts, including all pieces for hydraulic connection
- suspension brackets for mounting around construction column
- guards with opening for valve head
- thermostatic valve 5094.430
- lockshield 5094.431
- 4 chrome-plated air vents G 1/8"
- sleeve couplings: see Connection sets & Valves

### Standard colours:

- sandblast grey metallic 001
- white 301(RAL 9010 satin)
- white 333(RAL 9016 satin)

## Iguana CIRP

code height length colour conn.  
ORDERING CODE: CIRF. 180 027. XXX /MM/CL

H		L 027	031	034
180	75/65/20	1602	1893	2184
	90/70/20	2081	2460	2838

192	75/65/20	1707	2018	2328
	90/70/20	2211	2613	3015

200	75/65/20	1773	2096	2418
	90/70/20	2291	2708	3125

220	75/65/20	1923	2272	2622
	90/70/20	2471	2919	3369

240	75/65/20	2048	2421	2793
	90/70/20	2617	3094	3569

## Options

### Table in beech veneer

CODE	Type
9087.012660	Circo ø 27
9087.012730	Circo ø 31
9087.012800	Circo ø 34



### Large shelf in beech veneer

CODE	Type
9087.010637	Circo ø 27
9087.010672	Circo ø 31
9087.010707	Circo ø 34

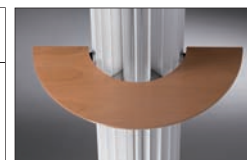

### Small shelf in beech veneer

CODE	Type
9087.011497	Circo ø 27
9087.011532	Circo ø 31
9087.011567	Circo ø 34



### Towel rail chrome-plated aluminium

CODE	Type
9087.013427	Circo ø 27
9087.013427	Circo ø 31
9087.013493	Circo ø 34



### Hat rack chrome-plated aluminium

CODE	Type
9087.014427	Circo ø 27
9087.014427	Circo ø 31
9087.014493	Circo ø 34



### Deco thermostatic head

CODE	Colour
5090.1111	chrome
5090.1110	chrome / white

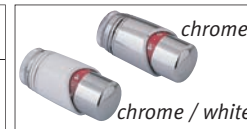

Output measured in accordance with EN442, at a water temperature of 75/65 and a room temperature of 20°C ( $\Delta T=50$ ).

1

2

1. Iguana Circo Wall Model (at the top)
2. Iguana Circo Wall Model (below)



# *Iguana Circo Wall Model*



# Iguana Circo Wall mounted model

## Dimensions

CIRW\_Circo Wall

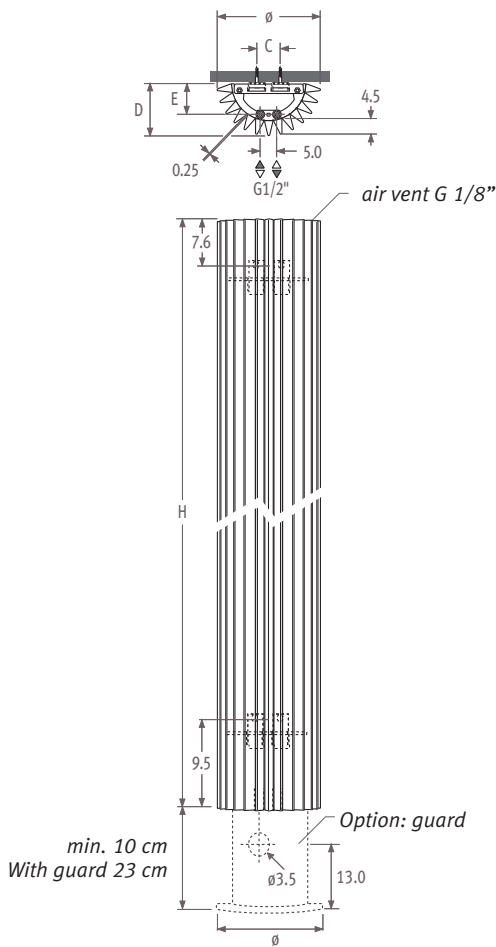

### Position flow and return pipe

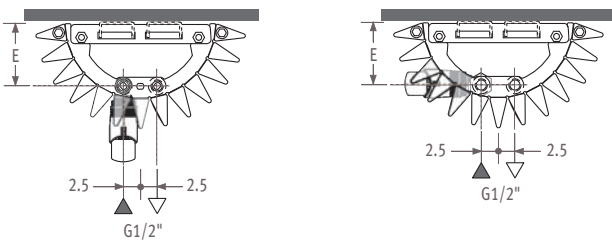

With connection sets 31-32-33-34-43-44  
Remark: flow and return can be reordered.

With connection sets 41-42

Dimensions in cm

$\emptyset$	27.8	31.3	34.8
C	7.4	10.8	14.4
D	14.2	15.7	17.7
E	7.7	9.6	11.5

## Connections

### Two pipe

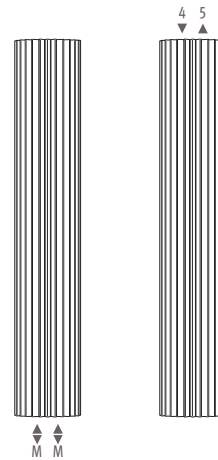

### Standard connection

Code MM

### Top end connection

Code 45 or 54

(1° number > flow)

When ordering a top end connection, no insert pipe should be ordered. Air vents should be positioned on the central heating pipes.

Ordering code: specify code 45 or 54 instead if MM, no surcharge.

### One pipe connection

The standard radiator can be connected to a one pipe system with connection sets 41 or 42. With a maximum of 2 radiators per heating ring.

### Notice

To guarantee the output of the Iguana models and to limit the pressure drop, Jaga recommends the use of tube diameter 16/2, 18/1 or 18/2.

## Dimensions options

### Table

	$\emptyset$	27.8	31.3	34.8
L		66.0	73.0	80.0
D		50.0	55.0	60.0

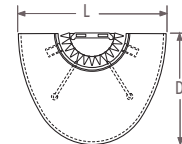

### Large shelf

	$\emptyset$	27.8	31.3	34.8
L		63.7	67.2	70.7
D		31.2	32.9	34.7

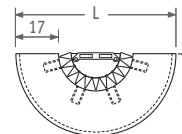

### Small shelf

	$\emptyset$	27.8	31.3	34.8
L		49.7	53.2	56.7
D		24.2	25.9	27.7

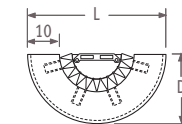

### Towel rail

	$\emptyset$	27.8	31.3	34.8
L		42.7	42.7	49.3
D		22.1	22.1	25.3

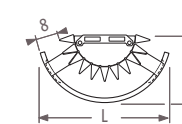

### Hat rack

	$\emptyset$	27.8	31.3	34.8
L		42.7	42.7	49.3
D		22.1	22.1	25.3

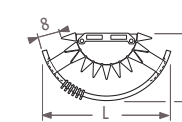

## Outputs



### Standard delivery:

- Circo Wall mounted model with central connection MM underneath
- wall fixing
- 2 chrome-plated air vents G 1/8"

### Standard colours:

- sandblast grey metallic 001
- white 301 (RAL 9010 satin)
- white 333 (RAL 9016 satin)

## Iguana CIRW

code height length colour conn.  
ORDERING CODE: CIRW. 180 027. XXX /MM

H		L 027	031	034
180	75/65/20	801	946	1092
	90/70/20	1041	1229	1419
192	75/65/20	854	1009	1164
	90/70/20	1106	1307	1507
200	75/65/20	887	1048	1209
	90/70/20	1146	1354	1562
220	75/65/20	961	1136	1311
	90/70/20	1235	1460	1685
240	75/65/20	1024	1210	1397
	90/70/20	1309	1546	1785

## Options

### Table in beech veneer

CODE	Type
9087.012660	Circo ø 27
9087.012730	Circo ø 31
9087.012800	Circo ø 34

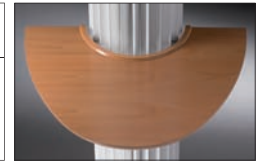

### Large shelf in beech veneer

CODE	Type
9087.010637	Circo ø 27
9087.010672	Circo ø 31
9087.010707	Circo ø 34

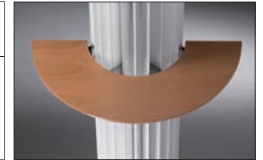

### Small shelf in beech veneer

CODE	Type
9087.011497	Circo ø 27
9087.011532	Circo ø 31
9087.011567	Circo ø 34



### Towel rail chrome-plated aluminium

CODE	Type
9087.013427	Circo ø 27
9087.013427	Circo ø 31
9087.013493	Circo ø 34



### Hat rack chrome-plated aluminium

CODE	Type
9087.014427	Circo ø 27
9087.014427	Circo ø 31
9087.014493	Circo ø 34



### Connection set with guard (colour to match radiator)

CODE	colour	Ø st.
COIG.28L.DW.3...	fill in sleeve coupling	27
COIG.28L.DC.3...		27
COIG.31L.DW.3...		31
COIG.31L.DC.3...		31
COIG.34L.DW.3...		34
COIG.34L.DC.3...		34

Remark: For flow right (set 44), R instead of L.  
Ex. COIG.28R.DW.3... ..

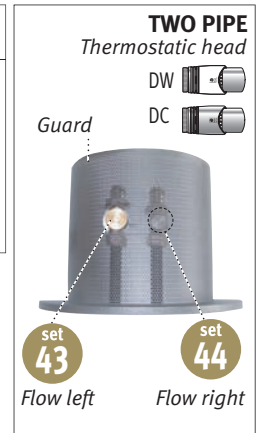

Output measured in accordance with EN442, at a water temperature of 75/65 and a room temperature of 20°C ( $\Delta T=50$ ).

Price incl. thermostatic valve, lockshield and sleeve couplings.  
For connection to the wall: order 2 curves.  
Sleeve couplings for connection sets with cover plate see p.209.  
ATTENTION: floorboards need to be removed for the guard.

1

2

1. Iguana Circo Corner (at the top)
2. Iguana Circo Corner (below)



# *Iguana Circo Corner*



# Iguana Circo Corner

## Dimensions

### CORW\_Corner Wall

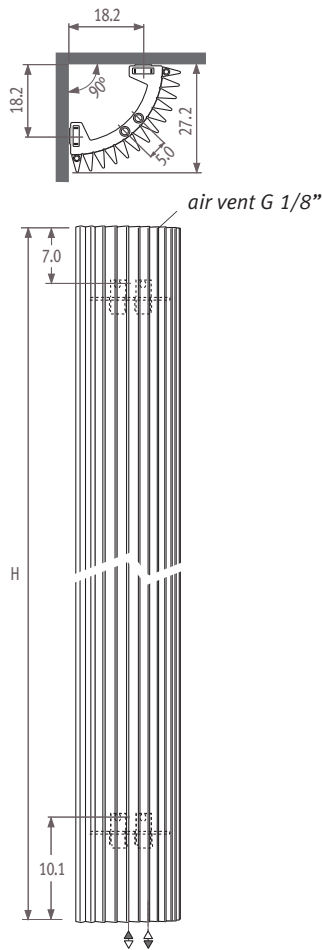

### Position flow and return pipe

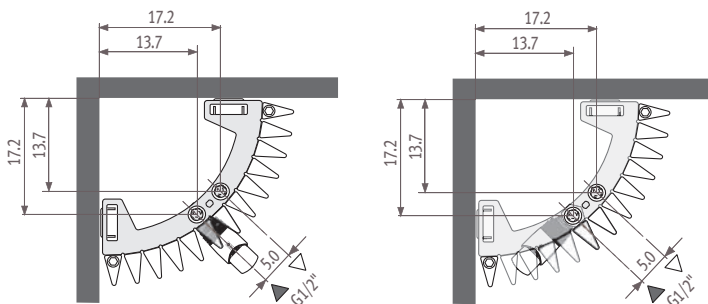

With connection sets 31-32-33-34

With connection sets 41-42

Remark: flow and return can be reordered.

## Connections

### Two pipe

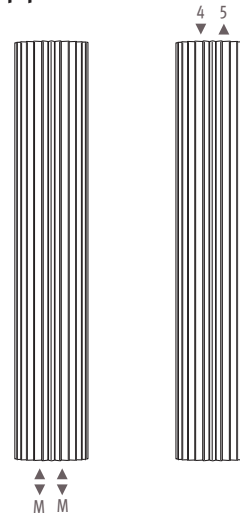

### Standard connection

Code MM

### Top end connection

Code 45 or 54

(1° number > flow)

When ordering a top end connection, no insert pipe should be ordered. Air vents should be positioned on the central heating pipes.

Ordering code: specify code 45 or 54 instead of MM, no surcharge.

### One pipe connection

The standard radiator can be connected to a one pipe system with connection sets 41 or 42.

With a maximum of 2 radiators per heating ring.

### Notice

To guarantee the output of the Iguana models and to limit the pressure drop, Jaga recommends the use of tube diameter 16/2, 18/1 or 18/2.

## Dimensions options

### Large shelf

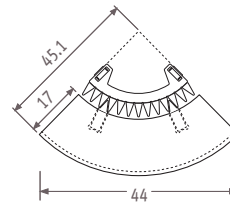

### Small shelf

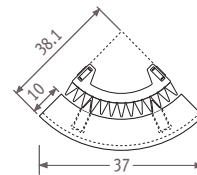

### Towel rail

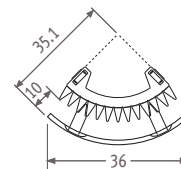

### Hat rack

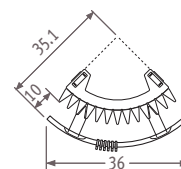



## Outputs

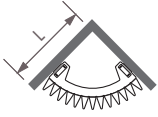

### Standard delivery:

- Circo Corner with central connection MM underneath
- wall fixing
- 2 chrome-plated air vents G 1/8"

### Standard colours:

- sandblast grey metallic 001
- white 301 (RAL 9010 satin)
- white 333 (RAL 9016 satin)

## Iguana CORW

code height length colour conn.  
ORDERING CODE: CORW. 125 027. XXX /MM

H	L 027	
125	75/65/20	723
	90/70/20	952
150	75/65/20	834
	90/70/20	1100
180	75/65/20	967
	90/70/20	1277
192	75/65/20	1021
	90/70/20	1350
200	75/65/20	1058
	90/70/20	1399
220	75/65/20	1149
	90/70/20	1521
240	75/65/20	1242
	90/70/20	1646



Output measured in accordance with EN442, at a water temperature of 75/65 and a room temperature of 20°C ( $\Delta T=50$ ).

## Options

### Large shelf in beech veneer

#### CODE

9087.040628



### Small shelf in beech veneer

#### CODE

9087.041528



### Towel rail chrome-plated aluminium

#### CODE

9087.043466



### Hat rack chrome-plated aluminium

#### CODE

9087.044466





# *Iguana Aplano*



# Iguana Aplano

## Dimensions

### APLW\_Aplano Wall

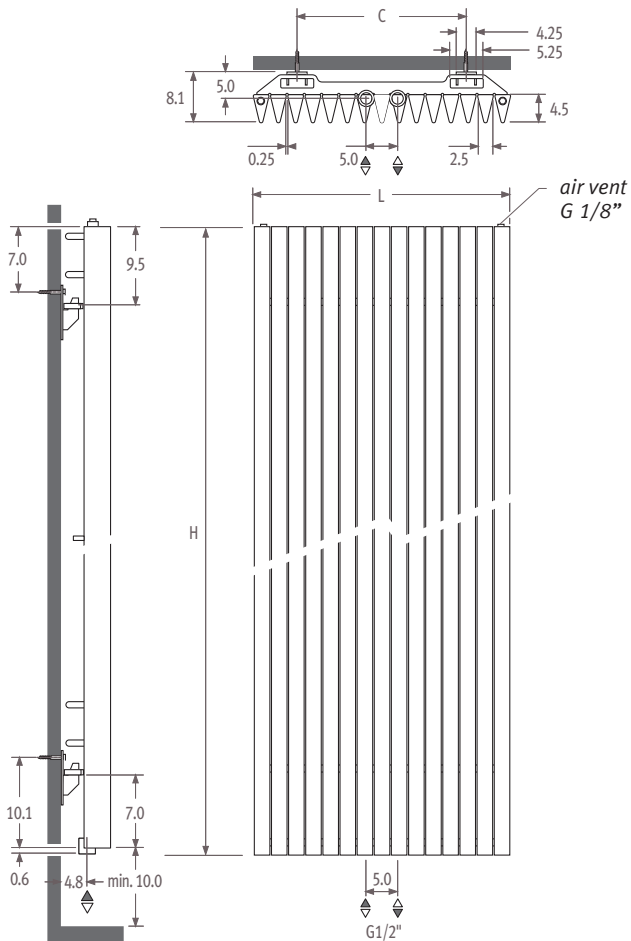

Dimensions in cm

L	31	41	52	63	74	85
C	16.0	27.0	38.0	49.0	60.0	71.0

## Connections

### Two pipe

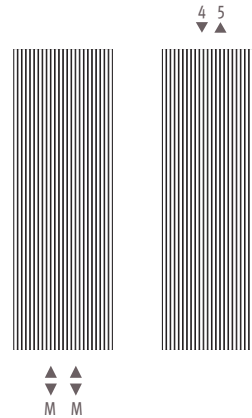

### Standard connection Code MM

#### Top end connection

Code 45 or 54

(1° number > flow)

When ordering a top end connection, no insert pipe should be ordered. Air vents should be positioned on the central heating pipes.

Ordering code: specify code 45 or 54 instead if MM, no surcharge.

#### One pipe connection

The standard radiator can be connected to a one pipe system with connection sets 41 or 42. With a maximum of 2 radiators per heating ring.

#### Notice

To guarantee the output of the Iguana models and to limit the pressure drop, Jaga recommends the use of tube diameter 16/2, 18/1 or 18/2.

## Dimensions options

### Large shelf

Aplano	30	41/52	63/74/85
L	-	40.0	40.0
D	-	26.1	26.1

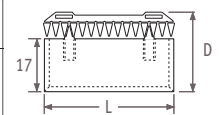

### Small shelf

Aplano	30	41/52	63/74/85
L	-	40.0	50.0
D	-	19.1	19.1

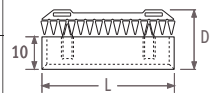

### Towel rail

Aplano	30	41/52	63/74/85
L	-	56.0	66.0
D	-	15.8	15.8

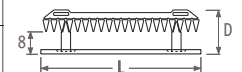

### Hat rack

Aplano	30	41/52	63/74/85
L	-	56.0	66.0
D	-	15.8	15.8

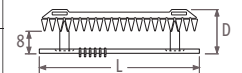

## Outputs

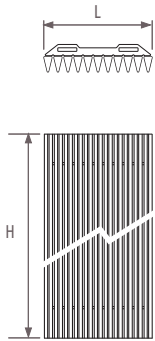

### Standard delivery:

- Aplano with central connection MM underneath
- wall fixing
- 2 chrome-plated air vents G 1/8"

### Standard colours:

- sandblast grey metallic 001
- white 301(RAL 9010 satin)
- white 333(RAL 9016 satin)

## Iguana APLW

code height length colour conn.  
ORDERING CODE: APLW. 180 030. XXX /MM

H		L 030	041	052	063	074	085
180	75/65/20	700	954	1208	1463	1717	1972
	90/70/20	895	1219	1544	1870	2194	2520
192	75/65/20	733	999	1265	1532	1798	2065
	90/70/20	936	1276	1616	1957	2296	2637
200	75/65/20	754	1028	1302	1576	1850	2124
	90/70/20	962	1312	1662	2012	2362	2711
220	75/65/20	804	1097	1389	1681	1974	2266
	90/70/20	1025	1399	1771	2144	2518	2890
240	75/65/20	851	1161	1471	1780	2090	2399
	90/70/20	1084	1479	1874	2268	2663	3056

## Options

### Large shelf in beech veneer

CODE	For Aplano	L
9087.030400	L 41-52-63-74-85	40

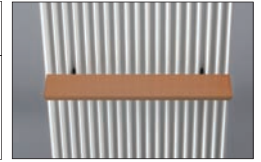

### Small shelf in beech veneer

CODE	For Aplano	L
9087.031400	L 41-52-63-74-85	40
9087.031500	L 52-63-74-85	50



### Towel rail chrome-plated aluminium

CODE	For Aplano	L
9087.033560	L 41-52-63-74-85	56
9087.033660	L 52-63-74-85	66



### Hat rack chrome-plated aluminium

CODE	For Aplano	L
9087.034560	L 41-52-63-74-85	56
9087.034660	L 52-63-74-85	66



Output measured in accordance with EN442, at a water temperature of 75/65 and a room temperature of 20°C ( $\Delta T=50$ ).



# Iguana Arco



# Iguana Arco

## Dimensions

### ARCW\_Arco Wall

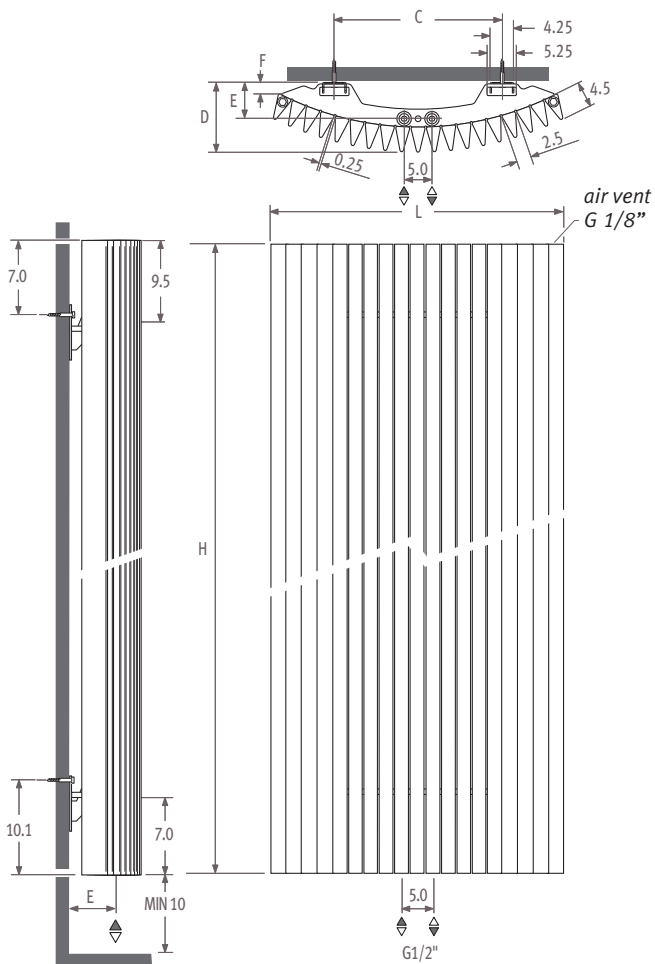

Dimensions in cm

L	29.8	41.0	51.9	62.5	73.3	83.9
C	10.0	20.0	30.0	40.0	50.0	60.0
D	10.1	11.1	12.7	12.2	13.7	15.7
E	4.1	5.1	6.7	6.2	7.7	9.7
F	3.6	2.9	2.3	3.0	2.5	2.4

## Connections

### Two pipe

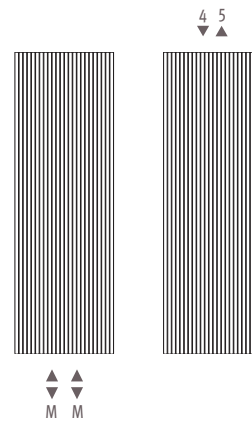

### Standard connection

Code MM

#### Top end connection

Code 45 or 54

(1° number > flow)

When ordering a top end connection, no insert pipe should be ordered. Air vents should be positioned on the central heating pipes.

Ordering code: specify code 45 or 54 instead if MM, no surcharge.

#### One pipe connection

The standard radiator can be connected to a one pipe system with connection sets 41 or 42. With a maximum of 2 radiators per heating ring.

#### Notice

To guarantee the output of the Iguana models and to limit the pressure drop, Jaga recommends the use of tube diameter 16/2, 18/1 or 18/2.

## Dimensions options

### Large shelf

Arco	29	41	51	62	73	83
L	-	53.0	53.0	54.0	54.0	54.0
D	-	28.9	30.5	30.0	31.5	33.5

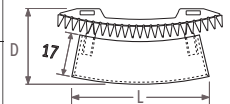

### Small shelf

Arco	29	41	51	62	73	83
L	-	48.0	48.0	51.0	51.0	51.0
D	-	21.9	23.5	23.0	24.5	26.5

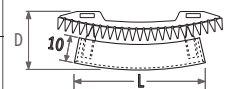

### Towel rail

Arco	29	41	51	62	73	83
L	-	55.0	55.0	66.0	66.0	66.0
D	-	18.8	20.4	19.9	21.4	23.4

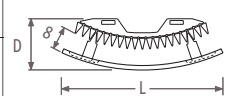

### Hat rack

Arco	29	41	51	62	73	83
L	-	55.0	55.0	66.0	66.0	66.0
D	-	18.8	20.4	19.9	21.4	23.4

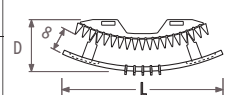



## Outputs

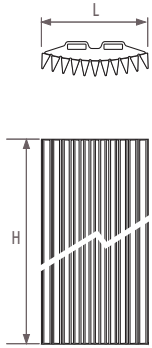

### Standard delivery

- Arco with central connection MM underneath
- wall fixing
- 2 chrome-plated air vents G 1/8"

### Standard colours:

- sandblast grey metallic 001
- white 301(RAL 9010 satin)
- white 333(RAL 9016 satin)

## Iguana ARCW

code height length colour conn.  
ORDERING CODE: ARCW. 180 029. XXX /MM

H		L 029	041	051	062	073	083
180	75/65/20	791	1079	1366	1654	1941	2229
	90/70/20	1011	1380	1747	2115	2482	2850
192	75/65/20	813	1109	1404	1700	1995	2291
	90/70/20	1039	1417	1794	2172	2549	2927
200	75/65/20	826	1127	1427	1727	2028	2328
	90/70/20	1055	1439	1822	2205	2590	2973
220	75/65/20	858	1170	1482	1794	2106	2418
	90/70/20	1094	1492	1890	2288	2686	3084
240	75/65/20	886	1208	1530	1852	2174	2496
	90/70/20	1129	1539	1949	2359	2770	3180

## Options

### Large shelf in beech veneer

CODE	For Arco	L
9087.020529	L 41-51	53
9087.020543	L 62-73-83	54



### Small shelf in beech veneer

CODE	For Arco	L
9087.021480	L 41-51	48
9087.021512	L 62-73-83	51



### Towel rail chrome-plated aluminium

CODE	For Arco	L
9087.023550	L 41-51	55
9087.023656	L 62-73-83	66



### Hat rack chrome-plated aluminium

CODE	For Arco	L
9087.024550	L 41-51	55
9087.024656	L 62-73-83	66



Output measured in accordance with EN442, at a water temperature of 75/65 and a room temperature of 20°C ( $\Delta T=50$ ).



*Iguana Visio*



# Iguana Visio

## Dimensions

VISW\_Visio Wall

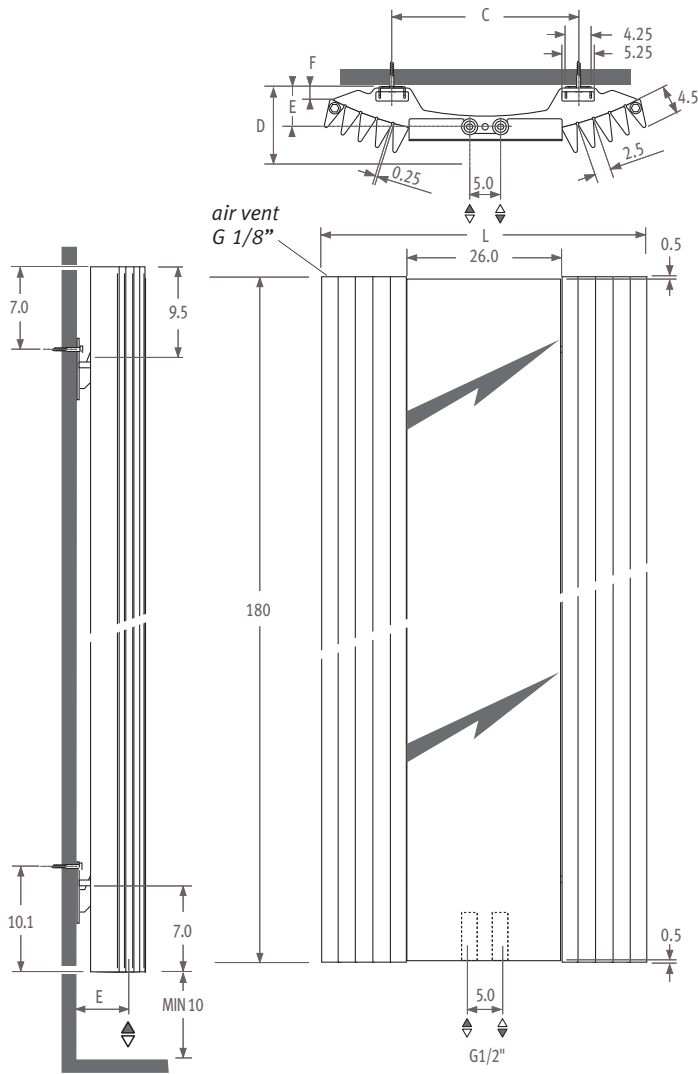

Dimensions in cm

<b>L</b>	<b>51.9</b>	<b>62.5</b>	<b>73.3</b>
<b>C</b>	30.0	40.0	50.0
<b>D</b>	10.7	11.2	12.7
<b>E</b>	6.7	6.2	7.7
<b>F</b>	2.2	3.0	2.5

## Connections

### Two pipe

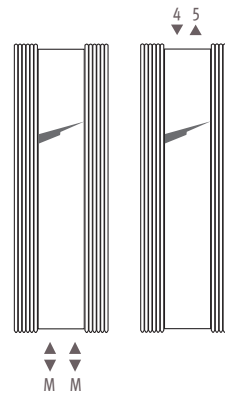

### Standard connection

Code MM

### Top end connection

Code 45 or 54

(1° number > flow)

When ordering a top end connection, no insert pipe should be ordered. Air vents should be positioned on the central heating pipes.

Ordering code: specify code 45 or 54 instead if MM, no surcharge.

### One pipe connection

The standard radiator can be connected to a one pipe system with connection sets 41 or 42. With a maximum of 2 radiators per heating ring.

### Notice

To guarantee the output of the Iguana models and to limit the pressure drop, Jaga recommends the use of tube diameter 16/2, 18/1 or 18/2.

## Dimensions options

### Large shelf

Visio	29	41	51	62	73	83
<b>L</b>	-	53.0	53.0	54.0	54.0	54.0
<b>D</b>	-	28.9	30.5	30.0	31.5	33.5

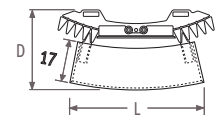

### Small shelf

Visio	29	41	51	62	73	83
<b>L</b>	-	48.0	48.0	51.0	51.0	51.0
<b>D</b>	-	21.9	23.5	23.0	24.5	26.5

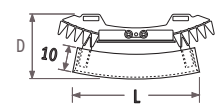

### Towel rail

Visio	29	41	51	62	73	83
<b>L</b>	-	55.0	55.0	66.0	66.0	66.0
<b>D</b>	-	18.8	20.4	19.9	21.4	23.4

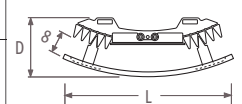

### Hat rack

Visio	29	41	51	62	73	83
<b>L</b>	-	55.0	55.0	66.0	66.0	66.0
<b>D</b>	-	18.8	20.4	19.9	21.4	23.4

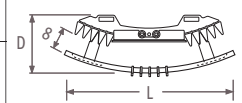

## Outputs

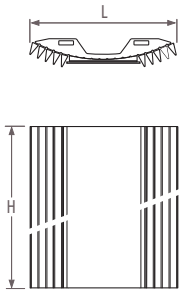

### Standard delivery:

- Visio with central connection MM underneath
- wall fixing
- 2 chrome-plated air vents G 1/8"

### Standard colours:

- sandblast grey metallic 001
- white 301(RAL 9010 satin)
- white 333(RAL 9016 satin)

## Iguana VISW

code height length colour conn.  
ORDERING CODE: VISW. 180 051. XXX /MM

H		L 051	062	073
180	75/65/20	719	1007	1294
	90/70/20	919	1288	1655
200	75/65/20	751	1051	1352
	90/70/20	959	1342	1726
220	75/65/20	780	1092	1404
	90/70/20	995	1393	1791

## Options

### Large shelf in beech veneer

CODE	For Visio	L
9087.020529	L 51	53
9087.020543	L 62-73	54



### Small shelf in beech veneer

CODE	For Visio	L
9087.021480	L 51	48
9087.021512	L 62-73	51



### Towel rail chrome-plated aluminium

CODE	For Visio	L
9087.023550	L 51	55
9087.023656	L 62-73	66

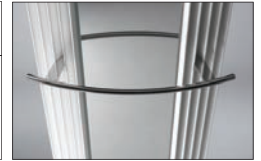

### Hat rack chrome-plated aluminium

CODE	For Visio	L
9087.024550	L 51	55
9087.024656	L 62-73	66



Output measured in accordance with EN442, at a water temperature of 75/65 and a room temperature of 20°C ( $\Delta T=50$ ).